

Art. Nr. / part no. Beschreibung

description

PORSCHÉ

Boxster Typ 987, 2006-2009

2.7l 176 kW; 2.7l 180 kW

Boxster S Typ 987, 2006-2009

3.2l 206 kW; 3.4l 217 kW

686106 1705

RACING Edelstahl-Sportauspuffanlage links und rechts, ab Vorkat, Serienhauptkat im Endschalldämpfer entfällt, mit 2 verchromten Edelstahl-Endrohren Ø 90 mm, ohne Genehmigung

Boxster Type 987, 2006-2009

2.7l 176 kW; 2.7l 180 kW

Boxster S Type 987, 2006-2009

3.2l 206 kW; 3.4l 217 kW

RACING stainless steel sport exhaust system L/R, no catalytic convertor, 2 chromed stainless steel tips Ø 90 mm, without homologation

1.852,00

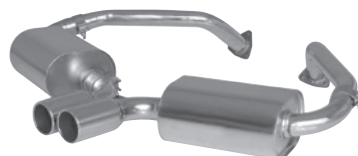
**Cayman Typ 987, 2006-2009**

2.7l 180kW

Cayman S Typ 987, 2006-2009

3.4l 217 kW

686106 1705

RACING Edelstahl-Sportauspuffanlage links und rechts, ab Vorkat, Serienhauptkat im Endschalldämpfer entfällt, mit 2 verchromten Edelstahl-Endrohren Ø 90 mm, ohne Genehmigung

Cayman Type 987, 2006-2009

2.7l 180kW

Cayman S Type 987, 2006-2009

3.4l 217 kW

RACING stainless steel sport exhaust system L/R, no catalytic convertor, 2 chromed stainless steel tips Ø 90 mm, without homologation

1.852,00

**Cayman Facelift Typ 987, 2009=>**

2.9l 195 kW

Cayman S Facelift Typ 987, 2009=>

3.4l 235 kW

689109 0500LR

Sportauspuffanlage li/re bestehend aus:

RACING Edelstahl-Sportauspuffanlage links und rechts (ohne Endrohre), ab Vorkat, Serienhauptkat im Endschalldämpfer entfällt, ohne Genehmigung

wählen Sie aus nachfolgendem Endrohrpaket:

689109 1698C

Endrohr-Set 2 Edelstahl-Endrohre Ø 98 mm Street Race

689109 1698CB

Endrohr-Set 2 Edelstahl-Endrohre Ø 98 mm Street Race Black Chrome

Cayman Facelift Type 987, 2009=>

2.9l 195 kW

Cayman S Facelift Type 987, 2009=>

3.4l 235 kW

Sport exhaust system L/R consisting of:

RACING stainless steel sport exhaust system L/R (without tail pipes), cat-back from front catalytic convertors, no secondary catalytic convertors

choose from following tail pipe package:

tail pipe set 2 stainless steel tail pipes Ø 98 mm Street Race

tail pipe set 2 stainless steel tail pipes Ø 98 mm Street Race Black Chrome

1.325,00

543,00

605,00





689109 0500LR



689109 1698C

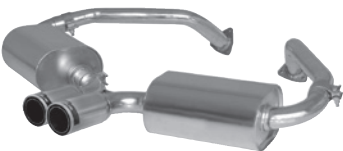

689109 1698CB

Art. Nr. / part no.	Beschreibung	description	
Boxster Facelift Typ 987, 2009=> 2.9l 188 kW (MA120)		Boxster Facelift Type 987, 2009=> 2.9l 188 kW (MA120)	
Boxster S Facelift Typ 987, 2009=> 3.4l 228 kW		Boxster S Facelift Type 987, 2009=> 3.4l 228 kW	
Boxster S Black Edition Typ 987, 2011=> 3.4l 235 kW		Boxster S Black Edition Type 987, 2011=> 3.4l 235 kW	
689308 1798C	RACING Edelstahl-Sportauspuffanlage links und rechts, ab Vorkat, Serienhauptkat im Endschalldämpfer entfällt, mit 2 Edelstahl-Endrohren Ø 98 mm Street Race, ohne Genehmigung	RACING stainless steel sport exhaust system L/R, cat-back from front catalytic converters, no secondary catalytic converters, 2 stainless steel Street Race tail pipes Ø 98 mm	1.852,00
689308 1798CB	RACING Edelstahl-Sportauspuffanlage links und rechts, ab Vorkat, Serienhauptkat im Endschalldämpfer entfällt, mit 2 matt-schwarz verchromten Edelstahl-Endrohren Ø 98 mm Street Race Black Chrome, ohne Genehmigung	RACING stainless steel sport exhaust system L/R, cat-back from front catalytic converters, no secondary catalytic converters, 2 satin black chromed stainless steel Street Race Black Chrome tail pipes Ø 98 mm	1.930,00
 <p>689308 1798C</p>		 <p>689308 1798CB</p>	

Boxster S Typ 981, 2012=> 3.4l 232 kW (MA123)		Boxster S Type 981, 2012=> 3.4l 232 kW (MA123)	
Boxster Typ 981, 2012=> 2.7l 195 kW (MA122)		Boxster Type 981, 2012=> 2.7l 195 kW (MA122)	
<u>Sportauspuffanlage li/re bestehend aus:</u>		<u>Sport exhaust system L/R consisting of:</u>	
689012 0500LR	Edelstahl-Sportauspuffanlage: Sportschalldämpfer links und Sportschalldämpfer rechts, ab Kat, mit EG Genehmigung	Stainless steel sport exhaust L/R, cat-back, EU approved for road usage	2.046,00
wählen Sie aus nachfolgendem Endrohrpaket:		choose from following tail pipe package:	
0027 98C	Endrohr-Set li/re je 1 Endrohr Ø 98 mm Street Race, kurz, mit einstellbarem Kugelanschluss	tail pipe set L/R each 1 tail pipe Ø 98 mm Street Race, short, with adjustable spherical clamp connection	295,00
0027 98CB	Endrohr-Set li/re je 1 Endrohr Ø 98 mm Street Race Black Chrome, kurz, mit einstellbarem Kugelanschluss	tail pipe set L/R each 1 tail pipe Ø 98 mm Street Race Black Chrome, short, with adjustable spherical clamp connection	332,00
 <p>689012 0500LR</p>		 <p>0027 98C</p>	 <p>0027 98CB</p>

Cayman, Typ 981C, 2012=> 2.7l 202 kW		Cayman, type 981C, 2012=> 2.7l 202 kW	
Cayman S, Typ 981C, 2012=> 3.4l 239 kW		Cayman S, type 981C, 2012=> 3.4l 239 kW	
<u>Sportauspuffanlage li/re bestehend aus:</u>		<u>Sport exhaust system L/R consisting of:</u>	
689012 0500LR	RACING Edelstahl-Sportauspuffanlage: Sportschalldämpfer links und Sportschalldämpfer rechts, ab Kat, ohne Genehmigung	RACING Stainless steel sport exhaust L/R, cat-back, without homologation	2.046,00
wählen Sie aus nachfolgendem Endrohrpaket:		choose from following tail pipe package:	
0027 98C	Endrohr-Set li/re je 1 Endrohr Ø 98 mm Street Race, kurz, mit einstellbarem Kugelanschluss	tail pipe set L/R each 1 tail pipe Ø 98 mm Street Race, short, with adjustable spherical clamp connection	295,00
0027 98CB	Endrohr-Set li/re je 1 Endrohr Ø 98 mm Street Race Black Chrome, kurz, mit einstellbarem Kugelanschluss	tail pipe set L/R each 1 tail pipe Ø 98 mm Street Race Black Chrome, short, with adjustable spherical clamp connection	332,00
 <p>689012 0500LR</p>		 <p>0027 98C</p>	 <p>0027 98CB</p>

Art. Nr. / part no.	Beschreibung	description	
911 Turbo Typ 996, 2000-2006 3.6l 309 kW (M9670)		911 Turbo Type 996, 2000-2006 3.6l 309 kW (M9670)	
911 Turbo S Typ 996, 2004-2006 3.6l Turbo 331kW (M96/70E)		911 Turbo S Type 996, 2004-2006 3.6l Turbo 331kW (M96/70E)	
911 GT2 Typ 996, 2004-2006 3.6l 355kW (M96/70SL); 3.6l 340kW (M96/70S)		911 GT2 Type 996, 2004-2006 3.6l 355kW (M96/70SL); 3.6l 340kW (M96/70S)	
689103 1506	RACING Edelstahl-Sportauspuffanlage inkl. Rennsportkat, links und rechts je 2 verchromte Edelstahl-Endrohre Ø 76/90 mm, ohne Genehmigung	RACING stainless steel sport exhaust L/R incl. race specification catalytic convertor, 4 chromed stainless steel tail pipes Ø 76/90 mm	3.286,00



911 Carrera / Carrera Cabrio Typ 997/1, Mai2004-2008 3.6l 239 kW		911 Carrera / Carrera Cabrio Type 997/1, May2004-2008 3.6l 239 kW	
911 Carrera S / Carrera S Cabrio Typ 997/1, Mai2004-2008 3.8l 261 kW		911 Carrera S / Carrera S Cabrio Type 997/1, May2004-2008 3.8l 261 kW	
2) 689305 0100	RACING Edelstahl-Krümmter links und rechts, ohne Genehmigung (originale Kats sind zu verwenden!)	RACING header system L/R, without homologation (use original catalytic converters!), without homologation	1.697,00
689305 1200	Racing Katersatzrohr links/rechts, ohne Genehmigung <u>Sportauspuffanlage li/re bestehend aus:</u>	Racing cat replacement tube left/right, without homologation <u>Sport exhaust system L/R consisting of:</u>	543,00
689405 0500LR	Edelstahl-Sportschalldämpfer links und rechts, mit EG Genehmigung, passend auf REMUS- oder Serienanlage	Stainless steel sport exhaust L/R, fits onto the REMUS or original front system, EU approved for road usage	1.953,00
689405 0606SLR	Endrohr-Set links und rechts je 2 verchromte Edelstahl-Endrohre Ø 90 mm schräg (Sportschalldämpfer und Endrohr-Set nur gemeinsam montierbar!)	tail pipe set L/R consisting of 4 chromed stainless steel tips Ø 90 mm angled (sport exhaust and tip set only fits as complete system!)	767,00



689305 1200

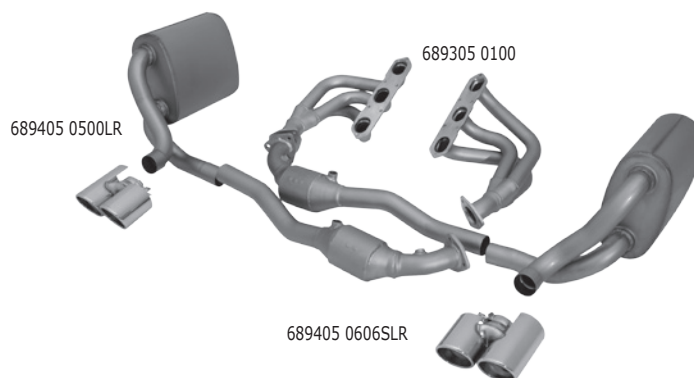

689405 0606SLR

911 Turbo Typ 997, 2006-2008 3.6l Turbo 353 kW (M97/70)		911 Turbo Type 997, 2006-2008 3.6l Turbo 353 kW (M97/70)	
688107 1574	Edelstahl-Sportauspuffanlage inkl. Katalysator, links und rechts je 2 verchromte Edelstahl-Endrohre Ø 76/84 mm, mit EG Genehmigung <u>alternativ: RACING Edelstahl-Sportauspuffanlage ohne Genehmigung</u>	Stainless steel sport exhaust L/R, with catalytic convertor, 4 chromed stainless steel tail pipes Ø 76/84 mm, EU approved for road usage <u>Alternative: Racing stainless steel sport exhaust system without homologation</u>	3.976,00
688307 1574	RACING Edelstahl-Sportauspuffanlage inkl. Rennsportkat, links und rechts je 2 verchromte Edelstahl-Endrohre Ø 76/84 mm, ohne Genehmigung	RACING stainless steel sport exhaust L/R, with race specification catalytic convertor, 4 chromed stainless steel tail pipes Ø 76/84 mm	3.449,00



688107 1574





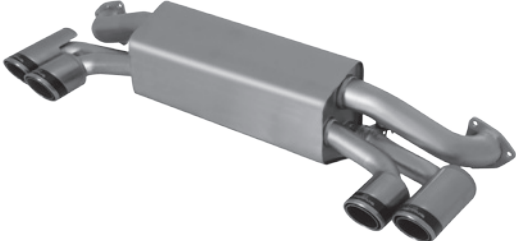

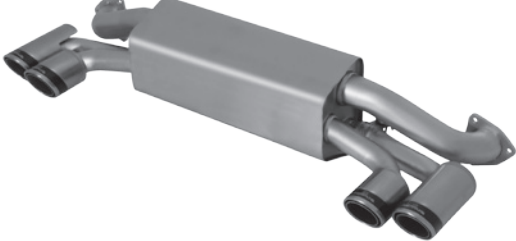
688307 1574

Art. Nr. / part no.	Beschreibung	description	CHF inkl. MwSt./ CHF ind. VAT
911 Carrera 4 Typ 991, 2013 => 3.4l 257 kW (MA104)		911 Carrera 4 Type 991, 2013 => 3.4l 257 kW (MA104)	
689612 1584CS	RACING Edelstahl-Sportauspuffanlage mit integriertem Klappensystem, ab Kat, links und rechts je 2 Edelstahl-Endrohre Ø 84 mm Carbon Race, ohne Genehmigung	RACING stainless steel sport exhaust system L/R with integrated valve system, cat-back, 4 stainless steel Carbon Race tips Ø 84 mm, without homologation	3.092,00
Klappensystem / valve system			
			

911 Carrera S Typ 991, 2011 => 3.8l 294 kW		911 Carrera S Type 991, 2011 => 3.8l 294 kW	
689612 1584CS	Edelstahl-Sportauspuffanlage mit integriertem Klappensystem, ab Kat, links und rechts je 2 Edelstahl-Endrohre Ø 84 mm Carbon Race, mit EG Genehmigung	Stainless steel sport exhaust system L/R with integrated valve system, cat-back, 4 stainless steel Carbon Race tail pipes Ø 84 mm, EU approved for road usage	3.092,00
Klappensystem / valve system			
			

Panamera S/4S Typ 970, (ohne originalen Klappensportschalldämpfer), 2009 => 4.8l 294 kW		Panamera S/4S Type 970, (without factory valve option), 2009 => 4.8l 294 kW	
Panamera / Panamera 4 Typ 970, 2010=> 3.6l 220 kW		Panamera / Panamera 4 Type 970, 2010=> 3.6l 220 kW	
Panamera Facelift / Panamera 4 Facelift Typ 970, 2013=> 3.6l 228 kW		Panamera Facelift / Panamera 4 Facelift Type 970, 2013=> 3.6l 228 kW	
Panamera Diesel Typ 970, 2011=> 3.0l 184 kW		Panamera Diesel Type 970, 2011=> 3.0l 184 kW	
688009 0500LR	<u>Sportauspuffanlage li/re bestehend aus:</u> Edelstahl Sportschalldämpfer links und Edelstahl Sportschalldämpfer rechts (ohne Endrohre), mit EG Genehmigung	L/R stainless steel sport exhaust system, with EEC homologation	1.542,00
0046 70QSS	wählen Sie aus nachfolgendem Endrohrpaket: Endrohr-Set li/re je 2 Endrohre Ø 102 mm schräg/schräg, verchromt, mit einstellbarem Kugelschluss	choose from following tail pipe package: tail pipe set L/R consisting of 4 tail pipes Ø 102 mm angled/angled, chrome, with adjustable spherical clamp connection	651,00
0046 70QSS	Endrohr-Set li/re je 2 Endrohre Ø 102 mm schräg/schräg Black Chrome, mit einstellbarem Kugelschluss	tail pipe set L/R consisting of 4 tail pipe Ø 102 mm angled/angled Black Chrome, with adjustable spherical clamp connection	732,00
		 0046 70QSS  0046 70QSS	
688009 0500LR			

Art. Nr. / part no.	Beschreibung	description	
Panamera Turbo Typ 970, 2009=> 4.8l V8 Turbo 368 kW (M4870)		Panamera Turbo Type 970, 2009=> 4.8l V8 Turbo 368 kW (M4870)	
Panamera Turbo Facelift Typ 970, 2013=> 4.8l V8 Turbo 382 kW		Panamera Turbo Facelift Type 970, 2013=> 4.8l V8 Turbo 382 kW	
Panamera S/4S Typ 970, (mit originalen Klappensportschalldämpfer), 2009 => 4.8l 294 kW		Panamera S/4S Type 970, (with factory valve option), 2009 => 4.8l 294 kW	
Panamera S Facelift/4S Facelift, Typ 970, 2013 => 3.0l 309 kW		Panamera S Facelift/4S Facelift Type 970, 2013 => 3.0l 309 kW	
689409 0300	Edelstahl-Sportvorschalldämpfer, ab Kat, mit EG Genehmigung, nur für Panamera Turbo, 2009=> und Panamera S Facelift/4S Facelift, 2013=> <u>Sportauspuffanlage li/re bestehend aus:</u>	Stainless steel front section with sport silencer, cat-back, EU approved for road usage, only suitable for Panamera Turbo, 2009=> and Panamera S Facelift/4S Facelift, 2013=> <u>Sport exhaust system L/R consisting of:</u>	767,00
689409 0500LR	Edelstahl Sportschalldämpfer links und Edelstahl Sportschalldämpfer rechts (ohne Endrohre), mit integriertem Klappensystem, mit EG Genehmigung wählen Sie aus nachfolgendem Endrohrpaket:	L/R stainless steel sport exhaust system, with integrated vacuum operated valves, with EEC homologation choose from following tail pipe package:	2.279,00
0046 70QSS	Endrohr-Set li/re je 2 Endrohre Ø 102 mm schräg/schräg, verchromt, mit einstellbarem Kugelanschluss	tail pipe set L/R consisting of 4 tail pipes Ø 102 mm angled/angled, chromed, with adjustable spherical clamp connection	651,00
0046 70QBSS	Endrohr-Set li/re je 2 Endrohre Ø 102 mm schräg/schräg Black Chrome, mit einstellbarem Kugelanschluss	tail pipe set L/R consisting of 4 tail pipe Ø 102 mm angled/angled Black Chrome, with adjustable spherical clamp connection	732,00
Cat-Back Anlage: Sportschalldämpfer in Verbindung mit Vorschalldämpfer.		Cat-Back system: Sport exhaust in connection with front silencer.	
			
689409 0500LR			
		0046 70QSS	
		0046 70QBSS	

Art. Nr. / part no.	Beschreibung	description	
Macan Turbo, Typ 95 B, 2014=> 3.6l Turbo 294 kW (CTL)		Macan Turbo, type 95 B, 2014=> 3.6l Turbo 294 kW (CTL)	
689014 0100	Edelstahl Vorrohre mit Dehnelementen (ab Kat), mit EG Genehmigung (Serienrohr Ø 65 mm, REMUS Rohr Ø 70 mm)	L/R stainless steel Cat-Back front tubes with flexible joints, with EEC homologation (Original tube Ø 65 mm, REMUS tube Ø 70 mm)	488,00
689014 0000	Edelstahl Verbindungsrohr doppelflutig (ab Vorrohr), mit EG Genehmigung (Serienrohr Ø 65 mm, REMUS Rohr Ø 70 mm) <u>Sportauspuffanlage li/re bestehend aus:</u>	Dual stainless steel connection tubes with crossover tube, with EEC homologation (Original tube Ø 65 mm, REMUS tube Ø 70 mm) <u>Sport exhaust system L/R consisting of:</u>	442,00
689014 0500LR	Edelstahl Sportschalldämpfer links und Edelstahl Sportschalldämpfer rechts (ohne Endrohre), mit integriertem elektrischem Klappensystem, mit EG Genehmigung (Serienrohr Ø 65 mm, REMUS Rohr Ø 70 mm) wählen Sie aus nachfolgendem Endrohrpaket:	L/R stainless steel sport exhaust system, fitted with integrated electrical actuators and valves, with EEC homologation (Original tube Ø 65 mm, REMUS tube Ø 70 mm) choose from following tail pipe package:	2.155,00
0046 70SS	Endrohr-Set li/re je 2 Endrohre Ø 102 mm schräg/schräg, verchromt, mit einstellbarem Kugelanschluss	tail pipe set L/R consisting of 4 tail pipes Ø 102 mm angled/angled, chromed, with adjustable spherical clamp connection	496,00
0046 70CSS	Endrohr-Set li/re je 2 Carbon-Endrohre Ø 102 mm schräg/schräg, Innenaufbau Titan, mit einstellbarem Kugelanschluss	tail pipe set L/R consisting of 4 Carbon tail pipe Ø 102 mm angled/angled, Titanium internals, with adjustable spherical clamp connection	1.147,00
Cat-Back Anlage: Sportschalldämpfer in Verbindung mit Racing Rohr.		Cat-Back system: Sport exhaust in connection with Racing tube.	
			
689014 0500LR			
		0046 70SS	
		0046 70CSS	

Art. Nr. / part no.	Beschreibung	description	
Cayenne I Turbo Typ 955, 2002-2006 4.5l Turbo 331 kW		Cayenne I Turbo Type 955, 2002-2006 4.5l Turbo 331 kW	
689303 1598C	Edelstahl-Sportauspuffanlage, links und rechts je 2 Edelstahl-Endrohre Ø 98 mm Street Race, mit EG Genehmigung	Stainless steel sport exhaust system L/R, 4 stainless steel Street Race tips Ø 98 mm, EU approved for road usage	1.473,00
			

Art. Nr. / part no.	Beschreibung	description	CHF inkl. MwSt/ CHF ind. VAT
Cayenne I Facelift Typ 957, 2007-2010 4.8l V8 Turbo 368 kW		Cayenne I Facelift Type 957, 2007-2010 4.8l V8 Turbo 368 kW	
689307 1506S	Edelstahl-Sportauspuffanlage, links und rechts je 2 verchromte Edelstahl-Endrohre Ø 90 mm schräg, mit EG Genehmigung	Stainless steel sport exhaust system L/R, 4 chromed stainless steel tail pipes Ø 90mm angled, EU approved for road usage	1.597,00



Cayenne II S Hybrid Typ 958, 2010=> 3.0l 245 kW (M06EC)		Cayenne II S Hybrid Type 958, 2010=> 3.0l 245 kW (M06EC)	
Cayenne II Turbo Typ 958, 2010=> 4.8l V8 Turbo 368 kW		Cayenne II Turbo Type 958, 2010=> 4.8l V8 Turbo 368 kW	
688010 1598C	Edelstahl-Sportauspuffanlage, links und rechts je 2 Edelstahl-Endrohre Ø 98 mm Street Race, mit EG Genehmigung	Stainless steel sport exhaust system L/R, 4 stainless steel Street Race tips Ø 98 mm, EU approved for road usage	1.473,00

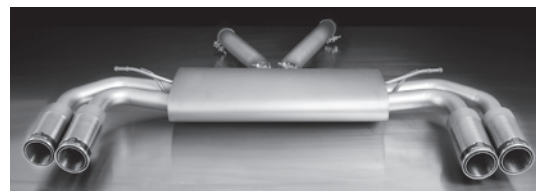

Cayenne II S V8 Typ 958, 2010=> 4.8l V8 294 kW (M4802)		Cayenne II S V8 Type 958, 2010=> 4.8l V8 294 kW (M4802)	
689110 1598C	Edelstahl-Sportauspuffanlage, links und rechts je 2 Edelstahl-Endrohre Ø 98 mm Street Race, mit EG Genehmigung	Stainless steel sport exhaust system L/R, 4 stainless steel Street Race tail pipes Ø 98 mm, EU approved for road usage	1.581,00
688010 1598C	RACING Edelstahl-Sportauspuffanlage, links und rechts je 2 Edelstahl-Endrohre Ø 98 mm Street Race, ohne Genehmigung	RACING stainless steel sport exhaust system L/R, 4 stainless steel Street Race tips Ø 98 mm	1.473,00



689110 1598C

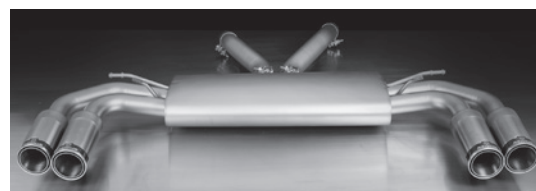

688010 1598C